

Tube Series User Manual

V1.0



Avalasia
sales@avalasia.com
Bruggestraat 112
BE-8930 Menen
+32 50 950 912

Specification:

Model	TL35
Microbolometer	
Type	Uncooled
Resolution, pixels	384x288
Pixel Size, μm	12
NETD, mk	≤ 50
Frame Rate, Hz	50
Optical Characteristics	
Objective Lens, mm	35
Field of View, $^{\circ}$	7.5x5.6
Magnification, x	3.0-12.0
Digital-zoom, x	1.0~ 4.0
Eye Relief, mm	70
Diopter Adjustment, D	-4 ~ +4
Detection Range, m (Target size:1.7m×0.5m, P(n)=99%)	1816
Display	
Type	LCOS
Resolution, pixels	1280x960
Operational Characteristics	
Battery	Built-in two 18650 batteries and a replaceable 18500 battery
Max. Operating Time (at temp.=22 $^{\circ}\text{C}$), h*	15
External power supply	5V (Type C USB)
Operational Characteristics	
Diameter of the riflescope body to assemble the mounting rings, mm	30
Max. Recoil Power on Rifled Weapon, g/s^2	1000
Encapsulation, IP class	IP67
Amount of built-in memory, GB	16
Operating Temperature Range, $^{\circ}\text{C}$	-20~+50
Weight (without replaceable battery), g	<950
Dimension, mm	385×85×75
USB Interface	Type-C

*The actual operation time depends on the intensity of using Wi-Fi, Video-Recording and other functions;

*The device and software may update for perfection of the product;

*Current version of User Manual can be found in official website: www.xinfrared.com.

1. Package List

- Tube series infrared thermal scope
- Eyecup
- Clip On adapter for Picatinny rail
- IPB-3 Portable bag
- Type C Cable
- Power adapter
- Cloth for lens wiping
- Certificate

2. Introduction

Tube series infrared scope is designed for outdoor and hunting. Base on the principle of Thermal Imaging, without external light source, ignoring strong light exposure, users can observe objectives (even hiding behind barriers: branches of tree, grass, bush) via Tube scopes, no matter it's day or night, bad weather such as rain, snow, fog, haze and etc.

Tube series scopes have multiple power supply plans, ensuring ultra-long operation duration, can be used for hunting, observation, locating in low visibility condition. Tube has 30mm standard pipe diameter, sures universal Clip-On interfaces.

3.Features

- 12 μ m Independent developed detector;
- High quality image;
- Stepless digital zoom;
- Double power supply systems, longer battery life;
- Standard 30mm pipe diameter;
- Stadia-metric rangefinder

- Long detection range;
- High frame frequency: 50Hz;
- Build-in storage, supports photographing and video recording
- Build-in WIFI module for connecting App
- Digital compass and gravity sensor;
- Picture in Picture (PIP)
- Defect pixel correction;
- User-friendly interface;

4. Parts

1. Eyecup
2. Diopter adjust ring
3. Photography Button
4. Brightness Button
5. Power Button
6. Palette Button
7. Rotary Encoder Knob
8. USB port cover
9. Type C port
10. LED indicator light
11. Extend battery lid
12. 18500 battery
13. Objective lens focus ring
14. Objective lens cap

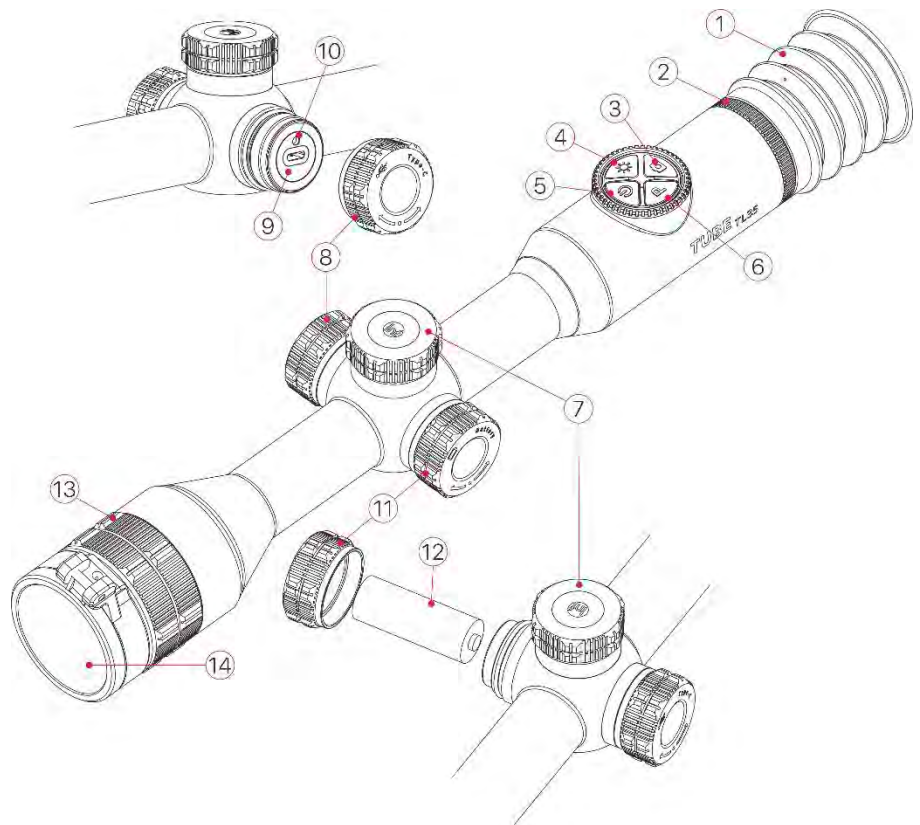

5. Functions of buttons

Button	Status/Current Operation mode	Short Press	Long Press	Rotate
Power Button	Switched Off	----	Switch On	----
	Main Menu	Shutter calibration	Switch Off/Standby	----
	Standby	Exit Standby	----	----
	Advanced Menu	Exit to previous menu without saving	----	----
	Pixel Calibration	Locate defect pixel or Cancel	----	----
Palette Button	Main Menu	Switch Palette	Switch On/Off PIP	----
Brightness Button	Main Menu	Adjust screen brightness	Switch On/Off Stadia-metric Rangefinder	----
Photography	Main Menu	Take photograph	Switch On/Off Video Record	----
Rotary Encoder Knob	Main Menu	Enter Shortcut Menu	Enter Advanced Menu	Adjust Zoom In level
	Shortcut Menu	Adjust parameters	Save & Exit to Home Screen	Switch Menu Options/Change
	Advanced Menu	Confirm selection & Back (Or enter submenu)	Save & Exit to Home Screen	Reticle Location: Rotate
	Pixel Calibration/Zeroing	Switch X/Y axis	Save & Exit to Home Screen	Clockwise: Move Left/Down



				Rotate Anti-clock wise: Move Right/Up
--	--	--	--	---

6.Charging Battery

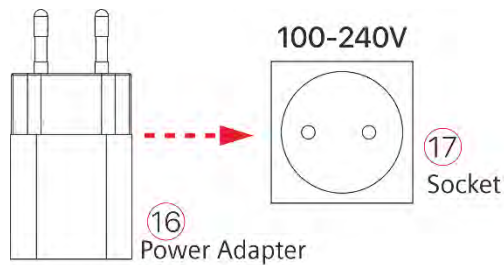
Tube series have double power supply system – built-in rechargeable lithium ion battery pack and a replaceable 18500 battery, the whole system supports standard working time: 15 hours. Please ensure the battery is fully charged before first time using.



Charging Built-in Battery Pack

- Rotate USB lid anti-clockwise to open it;
- Plug in the Type-C cable to Type-C port on Tube;
- Connect power adapter with another port of Type-C cable. Plug in the power adapter to socket with 100-240V for charging;
- When charging, there will be an icon in flash shape  appears in the icon of battery. Meanwhile the LED on device turns into red; when LED changed to green, indicates battery fully charged.
- While the icon turns into , means low battery, please charge on time, to avoid battery over discharge, resulting in device aging.

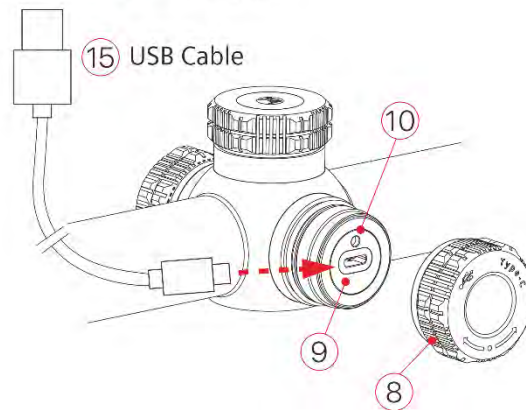

Tips: Only the built-in battery pack been charged while charging via USB port.

Installing 18500 battery

- Rotate Extend battery lid (11)

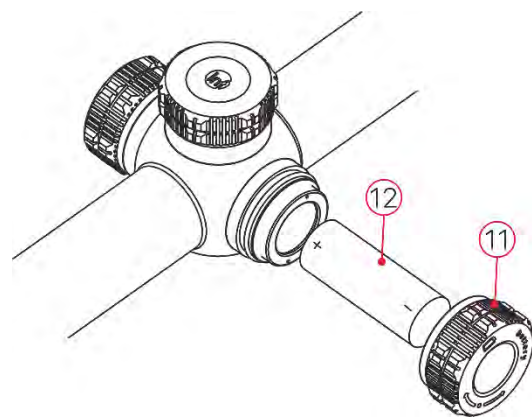

anti-clockwise to open it;

- Following the sign inside battery compartment, install 18500 battery (12) as anode electrode inward and negative electrode outward;
- Put on the battery compartment lid and screw down it clockwise.

Safety Measures

- Please charge with adapter as 5V2A in the package. Using other types of adapters may lead to irreversible damage to battery or adapter;
- If the device will be idle for a long time, it should be partial charged, avoid fully charged or completely discharge.
- When moved the device from cold environment to warm environment, wait for 30-40 minutes to warm up before charging the device, avoid charging instantly.
- Avoid to use the charger which been modified or damaged;
- Charge the scope in temperature range: $0^{\circ}\text{C}\sim+40^{\circ}\text{C}$, otherwise the battery life will be reduced significantly.
- Please don't leave the device unattended while charging;
- After fully charged, avoid connecting battery and adapter for over 24 hours;
- That is not recommended to connect with third device that has more power consumption than maximum.
- The device has short-circuited protection system, still, avoid circumstances of short-circuit.
- Recommend operation temperature range is $-20^{\circ}\text{C}\sim+50^{\circ}\text{C}$, avoid operating the device out of this temperature range, otherwise may reduce the battery life.
- When the device operating in subzero temperature, the capacity of battery drops, that is common, not defect.

Switching Battery Power Supply

Tube series support double power supply system: Built-in lithium ion battery pack and replaceable 18500 battery, also support USB port charging.

- If there are two types of batteries in Tube, the status bar on top right of the image will

reveal two battery icons. The replaceable battery on the left while build-in battery on the right. The icon turns to green, means charging device, turns to grey means not available.



- If there is no replaceable battery, there will be only one build-in battery icon in green, on the status bar.
- The device will select replaceable battery as power source when replaceable battery installed and with high power. While replaceable battery in low power, the device will switch to built-in battery as power supply.
- When the device connected with USB port, it will switch to external USB power supply. Then a lightning shaped icon will appear inside the icon of build-in battery, meanwhile charging build-in battery.
- When the device is operating, you can change the replaceable battery, then, the device will switch its power supply to build-in battery.

7.External Power Supply

Tube series support external power supply, such as mobile power bank (5V).

- Connect external power supply with USB port on Tube (9);
- The device will switch to external power supply, meanwhile charge build-in battery pack;
- When turned Off external power supply, the device will switch to replaceable 18500 battery. If there is no replaceable 18500 battery or battery low in power, the device will switch to build-in battery pack as power supply, instead of switch off the device.

8.Installation

Fixed installation

Warning! Don't aim the lens of infrared thermal imager to any high intensity radiation source, such as laser emitter or solar. Any damage that caused by not following instructions are not covered by warranty.

For accuracy of shooting, please install Tube to proper location on your weapon.

- For install Tube series, you need a jig to transfer it, such as the Picatinny rail adapter included in the package. Tube series designed as 30mm diameter pipe, suits 30mm standard clip on adapter, such as daylight scope. Base on the suggestions and instructions from supplier, choose proper tools to install Tube.
- During installation, adjust Tube installation position based on the distance between eyes and eyepiece (Eye-Relief in specification) and comfort. The eye piece may hurt shooter during shooting, if you not follow this advice.
- Suggest to install the scope as low as possible, also avoid contact with gun barrel and other parts;
- Suggest using torque wrench to fasten the screw when installing clip on adapter, to avoid screwed too tight to damage the scope, suggest torque: less than 2.5Nm;
- When hunting with scope, please zero your rifle refers to "Chapter 9 Zeroing" in this manual;
- Suggest cover the eyepiece lid when using scope at night or in dark environment, avoid being found.

Basic settings

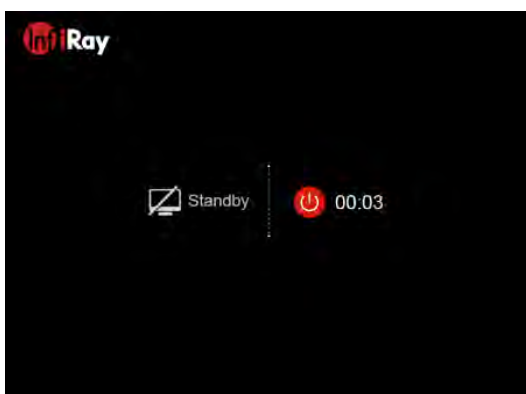

- Open the lens lid (14);
- Long press the power button (5) for 2 seconds, device start booting, wait 3 seconds before entering main menu, finish booting;
- Rotate the diopter adjust ring (2) to adjust the clarity of icons on the screen;
- Rotate the focal length adjust ring (13) on objective lens to adjust focal length;

- Set Image mode: in home screen, short press Palette button (6) for switching image mode, modes are White Hot, Black Hot, Pseudo color, Red Hot and Target highlight. The top status bar updates as image mode switches.
- Set screen brightness: In home screen, short press brightness button (4) to switch screen brightness in level 1–5, meanwhile brightness indication icon appears on the bottom of screen shortly, default brightness in level 3;
- Set image sharpness: short press rotary encoder knob (7) to set image sharpness (refer to 'shortcut menu'), default in level 1;
- Set image calibration types: select calibration types in advanced menu, including: Automatic(A), Manual(M) and Background(B), default is A;
- In home screen, short press power button (5) to calibrate. For background calibrate, please cover the lens with lid (14), the background calibration starts after 2s;
- While finished using the scope, long press power button (5) 3 secs to enter switch off countdown interface. Release the button after the device countdown to switch Off, from 3 to 0; a prompt of saving data appears on the screen, once finished saving data, screen turn to black screen, device switch Off. **Please don't cut off power supply when saving data, otherwise the data may not be saved.**
- Release button before countdown finish, then device enter standby mode, short press power button (5) to wake it up.



9.Zeroing

Tube series require zeroing in “Freeze” method, suggest zeroing in operating temperature of scope:

- Mount the scope on rifle with clip on adapter;
- Set a target on the distance, such as 100m,200m etc.;
- Adjust scope refer to the instructions in Charter 8 Basic Settings;
- Select Correction Type (Refer to “Reticle Settings – Zeroing” in Main Menu);
- Long press rotary encoder knob (7) to enter Main Menu, select “Zeroing”; short press rotary encoder knob (7) to enter next level menu.
- Base on pre-set distance to target, select or add new distance for correction (Refer to Main Menu function: “**Zeroing - Zeroing Range - Set Zeroing Distance**”);
- Once set zeroing distance, rotate rotary encoder knob (7) to select ‘zeroing’ option, short press rotary encoder knob (7) to enter zeroing interface (refer to advanced menu “zeroing settings-zeroing distance-zeroing interface”), the cross reticle will reveal in the center of screen, and the location of reticle will reveal in the top left corner of screen.
- Aim and shoot the target;
- Observe the location of impact, if the location of impact and aiming (the center dot of cross reticle) are not aligned, keep the scope still, long press both Palette button (6) and Photo button (3), then image freeze, meanwhile a symbol of freeze  will appear on the left of the screen.
- Short press rotary encoder knob (7) to switch between X-axis or Y-axis, the location of cursor  represent current selected option, and the icon turn into blue;
- Then rotate rotary encoder knob (7) to move the cursor, rotate clockwise to move cursor left or down, counter clockwise to move cursor right or up;
- Once finished moving, short press rotary encoder knob (7) to switch to another axis, also



autosave the position of cursor.

- When reticle moved to the position of real impact, long press rotary encoder knob (7) to save the position of reticle and exit to main menu.
- Repeat previous steps until the position of aiming aligned with position of impact.

Tips: When zeroing set, you can switch **ranges** in shortcut menu.

10. Calibration

When there are degraded or unbalanced image, calibration may fix the issue. Calibration balanced the background temperature to remove defects in imaging;

Calibration types including: Automatic(A), Manual(M) and Background(B).

Select calibration type in advanced menu.

- Automatic(A): Device will calibrate automatically, according to programs, don't need to cover lens lid (sensor will shut down internal shutter). Before automatic calibration, there will be a 5 secs countdown behind the shutter icon on status bar. Short press power button (5) to cancel the shutter calibration, during count down. Users can calibrate the shutter manually by short press power button (5) in this mode.
- Manual(M): in home screen, short press Power Button (5) to calibrate shutter manually, without covering lens lid (sensor will shut down internal shutter).
- Background Calibration(B): cover the lens lid, short press Power Button (5), prompts appear on home screen as "cover lens during calibration", background calibration starts after 2s.

11. Digital Zoom

Tube series scopes supports stepless digital zoom in 3.0-12.0, enlarge images 1-4 times.

- In home screen, rotate the knob (7) to zoom in/out the image;
- Rotate clockwise to zoom in, counterclockwise to zoom out;



- The amplification factor appears in the mid of bottom on the screen, disappears in 2s, meanwhile the top status bar updates with current amplification factor;
- The knob rotates once, the image zooms in/out 0.3 times.

12. Photography & Video recording

Tube series have built-in 16GB storage for photography and video record. Graph and video files are named with time, suggest synchronize time and date in App settings before taking photograph and recording video. Refer to instructions on official website to download App.

Photography

- In home screen, short press photography button (3) to take photos, the image freezes 0.5 seconds, icon of camera appears on the top right corner of screen;
- Photos are stored in built-in storage.

Video Recording

- In home screen, long press photography button (3) to start recording;
- Recording icon and time prompt appear on the top right of screen, time format: 00:00:00(Hour: Minute: Second);
- When recording, short press photography button (3) to take photographs;
- Long press photography button (3) to stop and save recording;
- All videos and photos will be saved in built-in storage.



Tips:

- You can still manipulate menu while video recording;
- Photos and videos will be saved in the format as IMG_HHMMSS_XXX.jpg (photo),

VID_HHMMSS_XXX.mp4 (video) in built-in storage, HHMMSS-Hour/Minute/Second; XXX

-Three digits media file serial number;

- Can't reset the serial number of media files;

Caution:

- The maximum duration of recording video is 5 minutes, once exceeded 5 minutes, the video will be saved to a new file automatically;
- Built-in storage limited the number of files to store. Check the available space of storage regularly and transfer media files to other devices to release space in built-in storage.

Access to built-in storage

While the device switches ON and connect to computer, it will be identified as SD card. You can access to built-in storage and copy photos and videos.

- Connect device with PC via Type-C cable;
- Switch on the scope;
- Double click "This PC" on desktop, find and double click device named "Infiray". Double click device named 'Internal Storage' to access built-in storage.
- There are different folders in the storage, named with time, in the form:
xxxx(year)xx(month)xx(day);
- Inside folders are photos and videos taken in that day, photos named in the form IMG_HHMMSS_XXX.jpg, videos named in the form VID_HHMMSS_XXX.mp4 on the storage. HHMMSS-hours/minutes/seconds; XXX-three digits serial number.
- Select desired files or folders to copy or delete.

13.Status Bar



Status bar located on the top of the screen, demonstrate current status of the device, from

left to right are:

1. Current image mode (☀️:White Hot; 🌙:Black Hot; 🔥: Red Hot; 🐦: Target

Highlighting; 🌈: Pseudo Color)

2. Current zeroing type and range (such as A100m)

3. Ultra clear mode(🚫: Ultra clear Off; 👁️: Ultra Clear On)

4. Current Zoom in rate (such as 3.0×)

5. Calibration mode (In automatic shutter mode (A), there will be a count down icon placed

alphabet 'A' after the calibration icon🕒00:05, while 5 seconds before calibration)

6. Compass (will not appear when turned off)

7. Standby settings (default off)

8. Video output status (no icon when video output switched off)

9. Wi-Fi status(🚫: Wi-Fi off; 📶: Wi-Fi On and connected)

10. Clock (Download App InfiRay Outdoor to set time in the app)

11. Replaceable battery status (18500 battery)

12. Built-in battery pack status

Notice: when icon as green🟢, means charges more than 20%, enough charges; as red🔴,

means low battery, please charge the device; when there is a flash icon ⚡️inside, means

charging with external power supply, charging the build-in battery either.

14.Shortcut Menu

You can set a series of common functions in shortcut menu, including setting reticle type, reticle color, image sharpness, zeroing distance, long press rotary encoder knob to save and exit to home screen.

- In home screen, short press rotary encoder knob (7) to enter shortcut menu;
- Rotate rotary encoder knob (7) to switch following functions, selected options will be highlighted in background:
 - **Reticle Type:** rotate rotary encoder knob (7) to select icon of reticle, short press knob to select among six reticle types;

- **Reticle Color:** rotate rotary encoder knob (7) to select this option, short press knob to select reticle color as white, black, red, green;
- **Image Sharpness:** rotate rotary encoder knob (7) to select this option, short press encode knob to select image sharpness 1-2-3-4-5;
- **Zeroing range:** rotate rotary encoder knob (7) to select this option, short press knob to select default zeroing range;
- Long press rotary encoder knob (7) to save modifications and exit to main screen.

Tips: In shortcut menu, without any operations in 5s, the device will save current modification and exit to home screen.

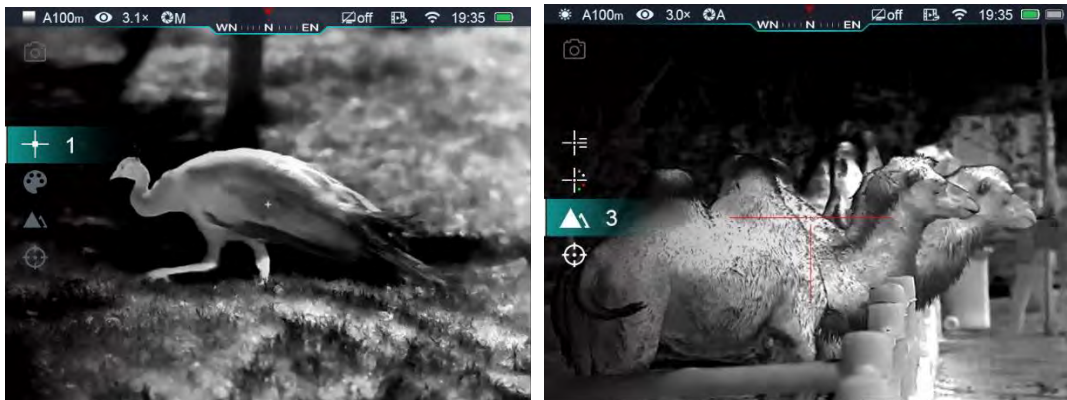

15. Advance Menu:



- In Main Menu, long press rotary encoder knob for 3 seconds to enter main menu, options including: Ultra-clear mode, Wi-Fi, Analog video output, Manual/Automatic shutter calibration, compass, gravity sensor, reticle, zeroing range, standby etc.
- Rotate rotary encoder knob (7) to switch main menu options, rotate clockwise to move down and counter clockwise to move up;
- The function options on main menu are in cycle: when cursor> located in the last option of first page, rotate knob clockwise, it will move to the first option on second page. When cursor> located in the first option of first page, rotate it counter clockwise, it will move to the last option on second page;
- Short press rotary encoder knob (7) to modify current parameters or enter next level of menu;

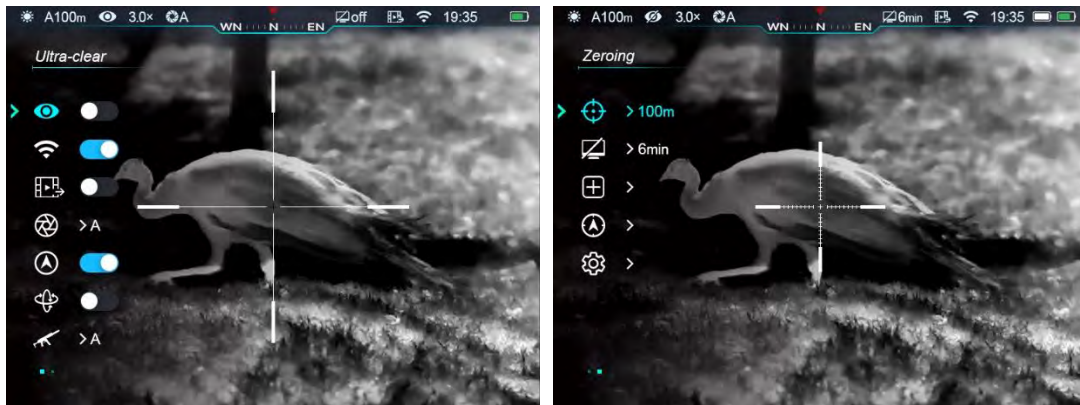



- The location of cursor indicates selected options, selected icon will change from white to blue;
- Same operations in second and third level menu;
- In all menu interfaces, long press rotary encoder knob (7) to save modification and exit to previous level of menu, short press power button (5) will exit to previous level without saving.
- In all menu, device will not save any modifications if no operations in 15s and exit to home screen.
- During operation, when exit from advance menu, the cursor> remains in the position before exit. When scope reboots, the first time enter advance menu, the cursor located in the first option of menu.



Main Menu Options and Descriptions

<p>Ultra-clear Mode</p> 	<p>Turn ON/OFF Ultra-Clear mode</p> <ul style="list-style-type: none"> ● Long press rotary encoder knob to enter advance menu; ● Select 'Ultra-clear' (cursor will remain on this option when first time in main menu) ● Short press rotary encoder knob to Turn ON or OFF this mode, along with the sound of shutter calibration; ● When Turn ON/OFF, the icon changes either. When there is a slash on icon, means close, otherwise, without slash, means opening.
<p>Wi-Fi</p>	<p>Select Wi-Fi status</p>

	<ul style="list-style-type: none"> ● Long press rotary encoder knob to enter Main Menu; ● Select “Wi-Fi” function via rotating rotary encoder knob; ● Short press rotary encoder knob to turn ON/OFF Wi-Fi; ● When Turn ON/OFF, the icon changes either. When there is a slash on icon, means close, otherwise, without slash, means opening.
<p>Video Output</p> 	<p>Turn ON/OFF video output</p> <ul style="list-style-type: none"> ● Long press rotary encoder knob to enter Main Menu; ● Select ‘Video output’ via rotate rotary encoder knob; ● Short press rotary encoder knob to switch ON/OFF video output; ● While output of video begins, an icon will reveal on the top status.
<p>Calibration</p> 	<p>Select calibration mode</p> <p>Rico series has three calibration modes: Automatic(A), Manual (M) and Background (B).</p> <ul style="list-style-type: none"> ● Select ‘Calibration’ ● Short press rotary encoder knob to next level of calibration; ● Rotate rotary encoder knob to select one mode from the following three modes: <ul style="list-style-type: none"> - Automatic shutter calibration (Automatic): controlled by programs, will calibrate automatically. - Manual shutter calibration (Manual): users can calibrate as them want, based on the imaging quality. - Background Calibration (Background) need to seal the lens with lid. ● Short press rotary encoder knob to confirm, while the icon in the status bar changes either.

	
<p>Compass</p> 	<p>Turn ON/OFF Compass function</p> <ul style="list-style-type: none"> ● Select “Compass”; ● Short press rotary encoder knob to Turn ON/OFF compass; ● When compass is turned on, it will reveal in the center of top status bar.
<p>Gravity Sensor</p> 	<p>Turn ON/OFF gravity sensor</p> <ul style="list-style-type: none"> ● Select “Gravity Sensor” function; ● Short press rotary encoder knob to Turn ON/OFF gravity sensor; ● Both sides of screen will layout relevant functions when turned on; ● The scale plate on the left means tilt angle, and the right one represents pitch angle. 
<p>Zeroing Profile</p> 	<p>Select zeroing type</p> <ul style="list-style-type: none"> ● Select zeroing type option; ● Short press rotary encoder knob to enter next level menu of zeroing type; ● Select one of Profile A/B/C via rotate rotary encoder knob; ● Short press rotary encoder knob to confirm, and exit to previous level of menu.



Please set zeroing profile and range before zeroing.
 Tube series support zeroing in ranges 1-999 meters.

- Select “Zeroing” in Main Menu;
- Short press rotary encoder knob to enter next level menu of zeroing, reveal three zeroing ranges;
- Rotate rotary encoder knob to select zeroing ranges, based on the ranges of target;
- Short press rotary encoder knob to confirm zeroing ranges then enter next level of zeroing ranges, including two options: zeroing and setting zeroing range;

Zeroing





Zeroing

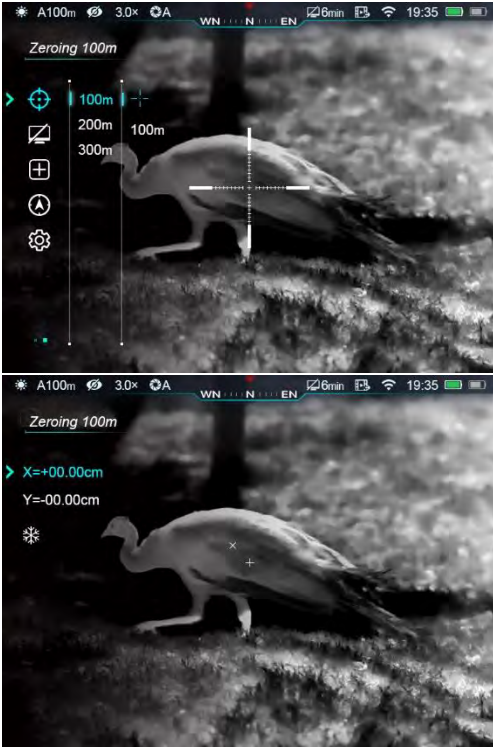

- Short press rotary encoder knob to enter zeroing menu, reticle changes to cross cursor. The top left reveals the X and Y coordinates;
- Aim the center of reticle with target’s bull’s-eye. Shot and observe the real impact location;
- Keep the scope still, hold down Palette button and Photo

		<p>button simultaneously, image freeze and icon of freeze reveals on the screen.</p> <ul style="list-style-type: none"> ● Short press rotary encoder knob to switch direction on X-axis or Y-axis, the position of cursor> identified selected option; ● Rotate rotary encoder knob to move reticle, clockwise to move cursor left or down, counter clockwise to move cursor right or up; ● Once movement done, short press rotary encoder knob to switch to another axis; ● Move cursor to the real impact location, long press rotary encoder knob to save the position of reticle and exit to submenu of zeroing; 
	<p>Setting Zeroing Range</p>	<p>If zeroing range is not same as set object, you can set range here.</p> <ul style="list-style-type: none"> ● Rotate rotary encoder knob to select 'Zeroing Range'; ● Short press rotary encoder knob to enable resetting

		<p>zeroing range;</p> <ul style="list-style-type: none"> ● Rotate rotary encoder knob to set each digit, short press rotary encoder knob to switch among hundreds, tens and units. ● While finished setting, long press rotary encoder knob to save and exit to zeroing settings, while ranges changed either. 
<p>Standby settings</p> 		<p>Set standby time and status</p> <ul style="list-style-type: none"> ● Select “Standby settings”; ● Short press rotary encoder knob to enter standby settings submenu, four options: 2min/4min/6min/off; ● Rotate rotary encoder knob to select option; ● Short press rotary encoder knob to confirm selection and reveal in the top status bar; ● Off means turn off standby mode; <p>Caution:</p> <ul style="list-style-type: none"> - Device will wake up from standby mode: tilt up >70°, tilt down >70°, tilt left >30°, tilt right >30°; - Scope will not standby while mounted rifle shots fire.









**Pixels Defect
Correction**







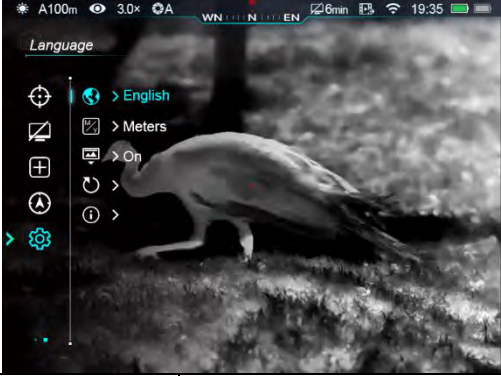

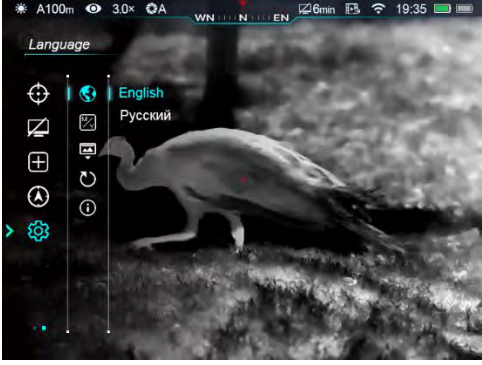
Some defect pixels may reveal on the screen after long period of operation. Defect pixels are pixels that do not change brightness compare with others, they are either brighter or darker than surrounding pixels. The pixels defect correction function will remove these bad pixels.

- Select “Pixels Correction”;
- Short press rotary encoder knob to enter correction interface, cross reticle appears in the center of screen, meanwhile turn on the Picture in Picture (PIP) function, default location: left bottom;
- On the right of PIP, there are some prompts showing the direction of cursor in X-axis, Y-axis and number of corrected pixels;
- Short press rotary encoder knob to switch between X-axis and Y-axis;
- Rotate rotary encoder knob to move reticle, clockwise to move cursor left or down, counter clockwise to move cursor right or up;
- Once movement done, short press rotary encoder knob to switch to another axis;
- Repeat previous operations until the reticle moved to the location of defect pixel;
- Short press Power button while reticle moved to the position of defect pixel, add and calibrate the pixel, there is a text ‘Add’ in PIP, then calibration finished. Repeat this step to calibrate other defect pixels;
- Short press power button on the same defect pixel position to cancel selection of calibration, there is a text ‘Del’ appear in PIP;
- The amount of defect pixels changes each time marking or cancel marking

	<p>pixels;</p> <ul style="list-style-type: none"> ● The PIP and its relevant information will move to top left of the screen when cursor moved to bottom left. ● Once correction finished, a prompt reveals when long press rotary encoder knob, asking whether save or not. Select 'Yes' to save and exit, select 'No' to cancel saving and exit. ● When selected Yes, a prompt 'Saving' appears on the screen; when a prompt 'Saving successful' appears, means saved then exit to home screen. 
<p>Compass Calibration</p> 	<p>Calibrate digital compass</p> <ul style="list-style-type: none"> ● Select 'Compass Calibration'; ● Short press rotary encoder knob to enter calibration menu with prompt of calibration; ● Follow the prompt to move the scope in three axes, as the noticed track goes, at least 360° per axis; ● Idle 15 seconds will exit without saving;

		
<p>General Settings</p> 	<p>Setting language, Units, Status autohiding, Factory reset, Info and etc.</p> 	
	<p>Language</p> 	<p>Select Language</p> <ul style="list-style-type: none"> ● Short press rotary encoder knob to enter submenu of General Setting; ● Select “language” option, short press rotary encoder knob to enter submenu of language setting; ● Rotate rotary encoder knob to select language; ● Short press rotary encoder knob to confirm, save and exit to menu; 
	<p>Units of Measure</p>	<p>Select “units of measure”</p> <ul style="list-style-type: none"> ● Short press rotary encoder knob to enter submenu of

	<p>General Setting;</p> <ul style="list-style-type: none"> ● Select 'units of measure', short press rotary encoder knob to its submenu; ● Rotate rotary encoder knob to select measuring units, short press rotary encoder knob to confirm, save and exit. 
<p>Status Auto Hiding</p> 	<p>Turn ON/OFF Status Auto Hiding</p> <ul style="list-style-type: none"> ● Short press rotary encoder knob to enter submenu of general setting; ● Select 'Status auto hiding' option, short press rotary encoder knob to enter submenu of status auto hiding; ● Rotate rotary encoder knob to select ON/OFF; ● Short press rotary encoder knob to confirm selection and exit to main menu; ● When turn ON autohiding, idle 8 secs, the icons or status bar will hide automatically, only imaging interface reveals; ● Short press any button to cancel auto hiding. 
<p>Factory Reset</p> 	<p>Reset to Factory settings</p> <ul style="list-style-type: none"> ● Short press rotary encoder knob to enter submenu of

		<p>General Setting;</p> <ul style="list-style-type: none"> ● Select “Factory Reset”, short press rotary encoder knob to enter submenu of this option; ● Rotate rotary encoder knob to select Yes/No. “Yes” means reset to factory settings, “No” means cancel; ● Short press rotary encoder knob to confirm selection; ● The scope will reboot when selected ‘Yes’; ● Select ‘No’ will cancel all previous operations and exit to upper menu. <p>The scope will reset to following default status when selected ‘Factory Reset’:</p> <ul style="list-style-type: none"> - Image mode: White Hot; - A100 Zeroing Range: A100 - Ultra-Clear mode: Off; - Digital Zoom: x3.0; - Shutter Calibration: Automatic; - Digital Compass: Off - Standby: Off; - Analog Video: Off - WiFi: Off - Gravity Sensor: Off 
	Info	Show device information



- Short press rotary encoder knob to enter Submenu of 'General Settings'
- Select 'Info';
- Short press rotary encoder knob will reveal relevant information of scope: product model, version info of Hardware and Software, PN code and SN code;
- Long press rotary encoder knob to exit to previous menu.



16. Picture in Picture (PIP)

The Picture in Picture (PIP) is a small screen in the top of main screen. The small screen shows enlarged $\times 2$ images of main screen regions which center on reticle.

- Long press P button (6) in Main Menu to switch ON/OFF PIP.
- When enlarged main screen image using rotary encoder knob, PIP image will be enlarged $2\times$ synchronously.



17. Stadiametric Rangefinder

Tube series have stadiametric rangefinder to estimate the range of a known object.

- In home screen, long press brightness button (4) to switch On/Off rangefinder.
- Once turned ON, there will be two lines in the mid of screen for measurement. On the right are three icons of preset objectives and its ranges;

- Three preset objects are:
 - Deer: 1.7m in height
 - Boar: 0.9m in height
 - Hare: 0.2m in height

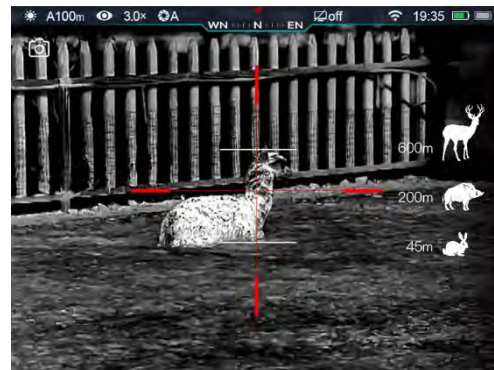

- Locate object in the center of screen, rotate rotary encoder knob (7) to adjust the height of object fully between the measuring lines. Rotate clockwise to extend the lines and counter clockwise to shrink. While adjusting the width of lines, the parameters on the right changes either;
- To change measuring unit, please refer to main menu – settings – unit setting to modify it.
- Long press brightness button (4) to exit stadiametric rangefinder.

18.Wi-Fi

Tube series include Wi-Fi module to connect with external devices (PC, smart phone) wirelessly.

- Switch on Wi-Fi on Main Menu (More details refer to Main Menu operations).
- Search for Wi-Fi signal named “Tube_XXXXXX” on external devices, XXXXXX is six digits serial number that consist of numbers and letters.
- Select this Wi-Fi signal, enter Password to connect, default password is 12345678;
- When Wi-Fi successfully connected, users can manipulate the device via App.

Set Wi-Fi name and password

Users can change Wi-Fi name and password of Tube series scopes via App.

- Access the setting menu in App by clicking the ‘gear’ icon  ;
- Input and submit new Wi-Fi name (ssid) and password;
- All settings will take effect after reboot of scope.

Caution! The Wi-Fi name and password will reset to default when the device reset to factory setting.



19. Updates and Apps

In order to improve the performance of Tube scope, the firmware, parameters and product instructions will be updated continuously. Users can download and update relevant files from official website: www.xinfrared.com.

When connected with smart phone or tablet PC, the following functions will be implemented via App: real time images synchronization, manipulating the scope and firmware update.

You may find instructions of Infiray Outdoor in official website: www.xinfrared.com.

Tips: Search and update firmware of devices via App Infiray Outdoor.

- You can get Infiray Outdoor App in official website: www.xinfrared.com; or search “Infiray Outdoor” in App store to download App; or scan the following QR code to download.



- When installation completed, open App Infiray Outdoor;
- If your scope is already connected with mobile device, please switch on the mobile data in mobile device. When scope connected to internet, there will be a prompt to advice update. Click ‘Now’ to download updates or click ‘Later’ to update later;
- If your device has not connected to your mobile device, but linked to App before (recorded); you can download the update files via Wi-Fi and connect the scope with mobile device to update the scope.
- Wait for update to complete, the device will root and ready to operate.

20. Technical Inspection

We suggest inspect the device every time before using it.

- Appearance: no crack on the shell;
- Status of object lens and eye piece (No crack, oil stain, dirt or other stains);
- Status of rechargeable battery (charged before using) and electrical contact (No salt or oxidation).

21. Maintenance

The scope should maintenance twice per year at least, including:

- Wipe the metal and plastic external surface of the scope, wipe out dust and dirt. May use silicone grease during the cleaning process.
- Clean electric contacts and battery jar with no greasy organic solvent.
- Check the surface of object lens and eye piece. If necessary, clean the dirt and sand on the lens (better avoid direct contact). Use specific wiping tools and solvents to clean the surface of lens.

22. Trouble shooting

The following table lists all potential issues of the device. Inspect and fix your device based on the suggestions in the table. If there are any issues that not included in the table or users cannot fix it themselves, users should contact sellers for overhaul.

Fault	Probable Cause	Solution
Can't switch on the scope	out of battery	charge the battery
Can't charge the scope with external power supply	USB cable broken	change USB cable
	external power supply out of battery	check external power supply if needed
Image not clear, not balanced, with strings	needs calibration	Refer to part 10 Calibration of this manual to calibrate
Image too dark	brightness too low	adjust brightness of screen
Image quality too low or short detection range	May due to weather condition, such as snow, rain, fog etc.	
Can't connect with smart phone and tablet PC	wrong Wi-Fi password	input correct password
	Too many Wi-Fi signals around device	Move device to area with no or low Wi-Fi signals
Wi-Fi signal disappear or interrupted	Device not covered by Wi-Fi signal or there is barrier between device and receiver (such as concrete wall)	Replace the device until Wi-Fi signal is stable
Compare with room temperature, the quality of image in low temperature is quite poor.	When temperature is above 0 Celsius, the object and background have different thermal conductivity which lead to large temperature difference. Image quality is higher in this case. In low temperature, object and background have similar temperature, that lead to small temperature difference, then poor image quality. This is a feature of thermal imaging device.	